



Shenzhen Hanlunda Industrial Co., Ltd.

HDD47-26U27A

输入电压范围	输出电压	输出电流	输出功率	效率	纹波	容性负载
18 - 36VDC	+5VDC	5A	25W	84%	50mVp-p	5000uF

规格参数 (所有参数均在额定24V输入, 25°C条件下测试, 特殊说明除外)	
输出规格	基本规格
输出功率	25W max. 效率 84%
输出电压	5VDC 隔离电压 2250VDC
电压调节范围	4.5 - 5.5VDC 开关频率 350KHZ
输出电压精度	±1% 安全 CAN/CSA C22.2 NO. 60950-1: 2007
纹波电压	50mVp-p max. UL60950-1: 2007
容性负载	5000uF max. EN 60950-1/A11:2009
	CE MARK
输入规格	尺寸
输入电压	18 - 36VDC 0.95 x 1.35 x 0.397Inch
开关控制	关闭 2.4 - 8VDC 24.1 x 34.3 x 10.1mm
	工作 -2 - 0.8VDC 重量 13.5g(0.476 oz)
	工作温度 -40 - 100°C
	存储温度 -45 - 125°C

Note 1: Output is terminated with 1μF ceramic and 22μF low-ESR tantalum capacitors.

For applications requiring reduced output voltage ripple and noise, consult applications support

Note 2: Recommended minimum output capacitance is 100uF

Note 3: Trim-up range is limited below 10% at low line and full load. Contact applications support for more detail

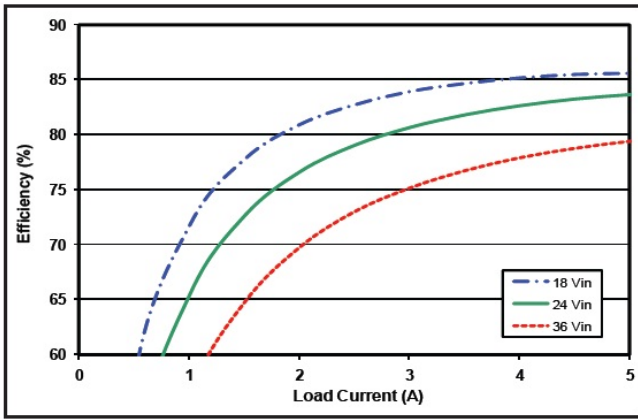

Figure 1: Efficiency at nominal output voltage vs. load current for minimum, nominal, and maximum input voltage at 25°C.

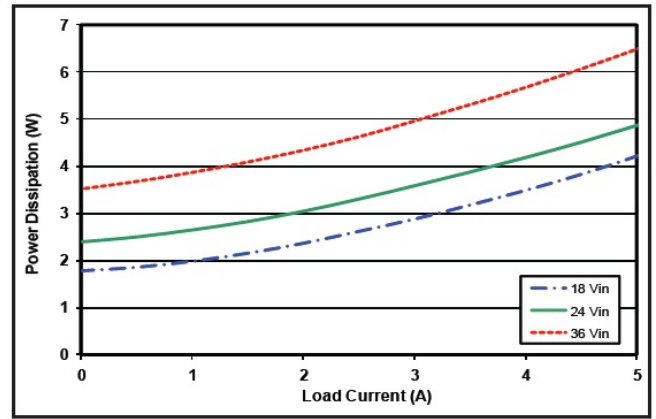

Figure 2: Power dissipation at nominal output voltage vs. load current for minimum, nominal, and maximum input voltage at 25°C.

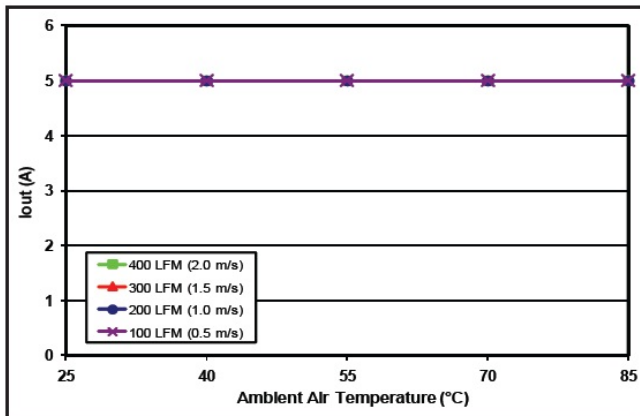

Figure 3: Encased converter max. output power derating vs. ambient air temperature for airflow rates of 100 LFM through 400 LFM. Air flows across the converter from pin 3 to pin 1 (nominal input voltage).

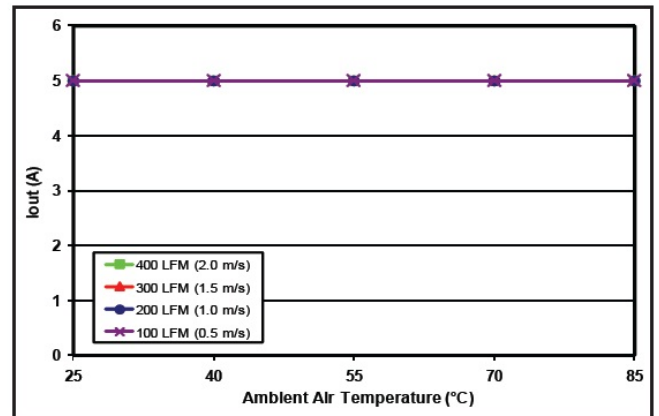

Figure 4: Encased converter (with 1/4" heatsink) max. output power derating vs. ambient air temperature for airflow rates of 100 LFM through 400 LFM. Air flows across the converter from pin 3 to pin 1 (nominal input voltage).

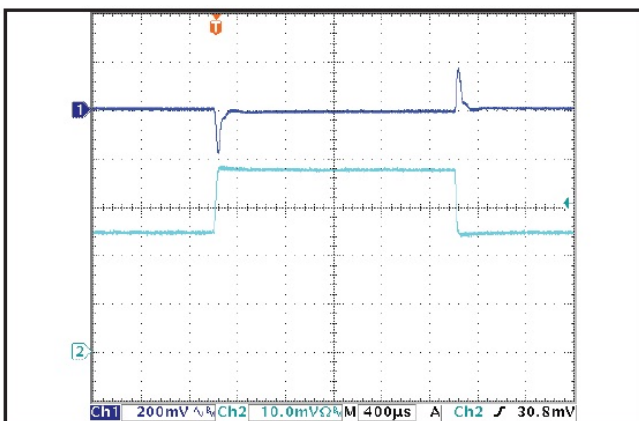

Figure 5: Output voltage response in the SM version to step-change in load current (50%-75%-50% of $I_{out(max)}$; $dI/dt = 0.1 A/\mu s$). Load cap: 100 μF electrolytic cap and 1 μF ceramic cap. Ch 1: V_{out} (200 mV/div), Ch 2: I_{out} (5 A/div).

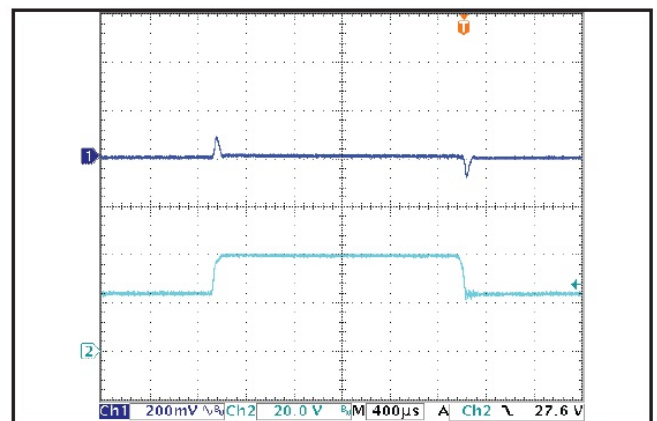
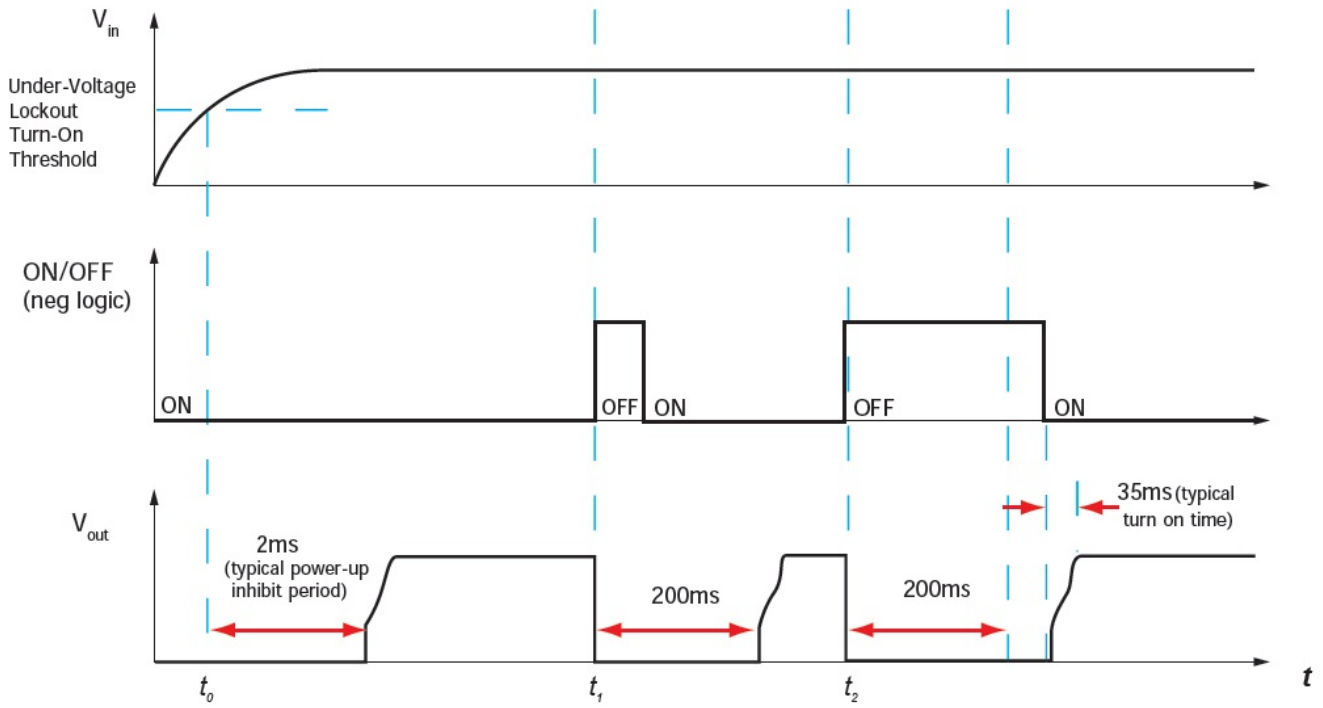
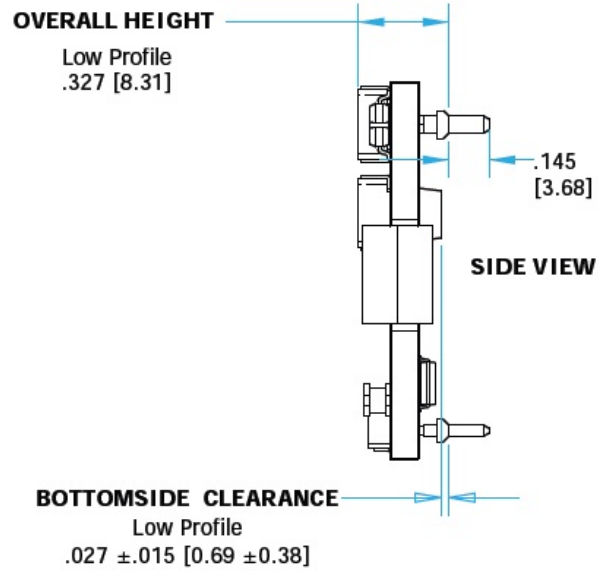
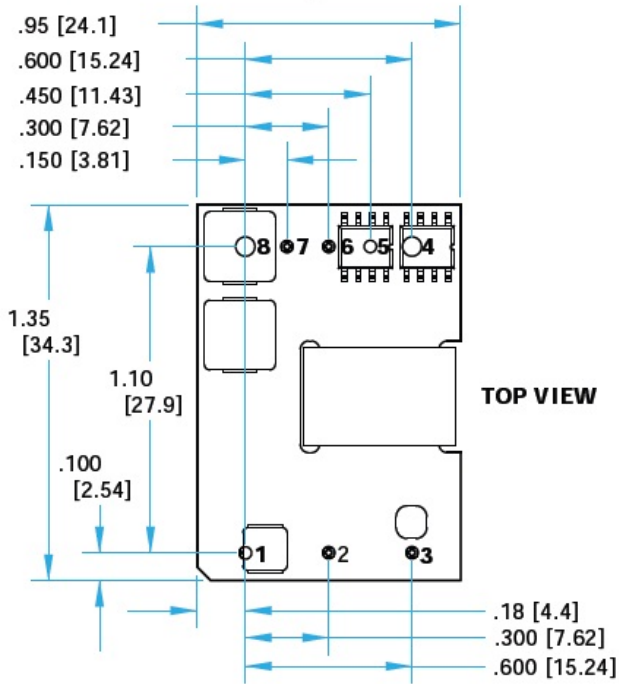

Figure 6: Output voltage response in the SM version to step-change in input voltage (250 V/ms). Load cap: 100 μF , electrolytic output capacitance. Ch 1: V_{out} (200 mV/div), Ch 2: V_{in} (10 V/div).



Mechanical Drawing



NOTES

- 1) Pins 1-3, 5-7 are 0.040" (1.02mm) diameter, with 0.080" (2.03mm) diameter standoff shoulders.
- 2) Pins 4 and 8 are 0.062" (1.57 mm) diameter with 0.100" (2.54 mm) diameter standoff shoulders.
- 3) Other pin extension lengths available. Recommended pin length is 0.03" (0.76mm) greater than the PCB thickness.
- 4) All Pins: Material - Copper Alloy- Finish (RoHS 6/6) - Matte Tin over Nickel plate
- 5) Undimensioned components are shown for visual reference only.
- 6) All dimensions in inches (mm) Tolerances: x.xx +/-0.02 in. (x.x +/-0.5mm) x.xxx +/-0.010 in. (x.xx +/-0.25mm)
- 7) Weight: .476oz (13.5g)
- 8) Workmanship: Meets or exceeds IPC-A-610C Class II
- 9) Open frame units have flanged pins are designed to permit surface mount soldering (avoid wave solder) using PiP technique.

PIN DESIGNATIONS

Pin	Name	Function
1	Vin(+)	Positive input voltage
2	ON/OFF	TTL input to turn converter on and off, referenced to Vin(-), with internal pull up.
3	Vin(-)	Negative input voltage
4	Vout(-)	Negative output voltage
5	SENSE(-)	Negative remote sense(see note 1)
6	TRIM	Output voltage trim (see note 2)
7	SENSE(+)	Positive remote sense (see note 3)
8	Vout(+)	Positive output voltage

Notes:

- 1) SENSE(-) should be connected to Vout(-) either remotely or at the converter.
- 2) Leave TRIM pin open for nominal output voltage.
- 3) SENSE(+) should be connected to Vout(+) either remotely or at the converter.